



L59U Series Snapfit Low Profile LED Ø.250" Panel Mount Indicator



Description and Features

- **SNAPFIT LOW PROFILE LED INDICATOR LIGHTS**
- **1/4" DIA. MOUNTING HOLE**
- **BLACK NYLON HOUSING WITH INTEGRAL BEZEL • 6" WIRE LEADS**
- **CLEAR OR DIFFUSED LED • VARIOUS LED COLORS • 2 TO 24 VOLTS D.C.**

The L59U Series LED indicators are constructed with a low profile black nylon housing with integral bezel.

Each unit is supplied with a high brightness clear or diffused LED and two color-coded 6" wire leads.

Standard voltages range from 2 to 24VDC.

Indicators snapfit into 0.250" (6.35mm) diameter mounting hole with a recommended panel thickness range of 0.030" to 0.062" [0.762mm to 13.575mm] thick.

Current: 20mA typical.

Housing: black nylon.

LED Lens: clear (L59UC) or diffused (L59UD).

LED DC voltage options: 2 to 24 volts DC.

Wire Leads: 6"±0.125" [152.4mm±3.17mm], #24 AWG prebonded copper, thin wall PVC, UL/CSA rated 105° C, stripped 1/2". A red wire lead which denotes the anode (+) while a black wire lead identifies the cathode (-). Custom wire lengths, stripping, termination and wire types are available.

Other LEDs: bi-color, low current or ultra bright.

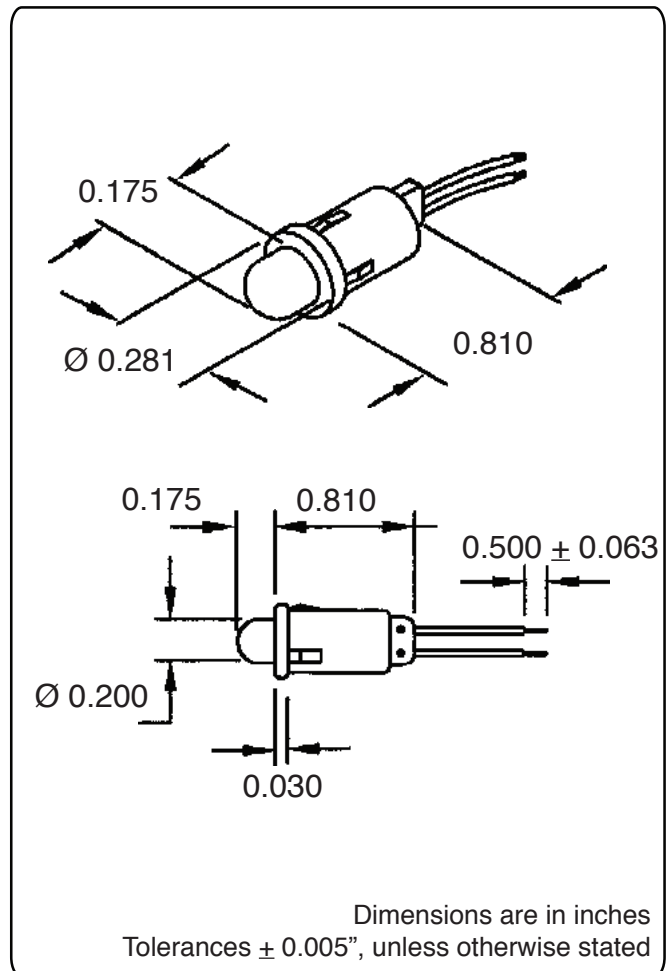

Ordering Data

LED Indicator Light
2 to 24 Volts DC
Clear or Diffused LED
1/4" Mounting Hole

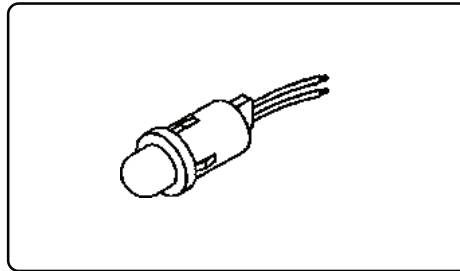

6" Wire Leads
Black Nylon Housing
With Integral Bezel
Various LED Colors
SnapFit Mounting

Part Number	Lens Style	Lens Color	Design Volts DC	Typical Intensity (mcd)	Typical Viewing Angle
L59UC-G2-W	Clear	Green	2	50	30°
L59UC-G6-W	Clear	Green	6	50	30°
L59UC-G12-W	Clear	Green	12	50	30°
L59UC-G24-W	Clear	Green	24	50	30°
L59UC-R2-W	Clear	Red	2	50	30°
L59UC-R6-W	Clear	Red	6	50	30°
L59UC-R12-W	Clear	Red	12	50	30°
L59UC-R24-W	Clear	Red	24	50	30°
L59UC-Y2-W	Clear	Yellow	2	50	30°
L59UC-Y6-W	Clear	Yellow	6	50	30°
L59UC-Y12-W	Clear	Yellow	12	50	30°
L59UC-Y24-W	Clear	Yellow	24	50	30°
L59UD-G2-W	Diffused	Green	2	15	60°
L59UD-G6-W	Diffused	Green	6	15	60°
L59UD-G12-W	Diffused	Green	12	15	60°
L59UD-G24-W	Diffused	Green	24	15	60°
L59UD-R2-W	Diffused	Red	2	10	60°
L59UD-R6-W	Diffused	Red	6	10	60°
L59UD-R12-W	Diffused	Red	12	10	60°
L59UD-R24-W	Diffused	Red	24	10	60°
L59UD-Y2-W	Diffused	Yellow	2	20	60°
L59UD-Y6-W	Diffused	Yellow	6	20	60°
L59UD-Y12-W	Diffused	Yellow	12	20	60°
L59UD-Y24-W	Diffused	Yellow	24	20	60°

Polarity Determination - Wire Leads: Red wire lead denotes anode (+); black wire lead denotes cathode (-).