

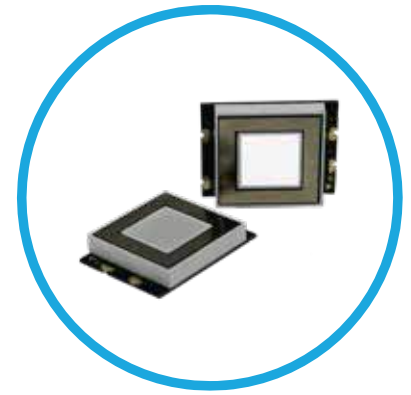

CSM Series Capacitive Touch Sensor Display 15.0 x 15.0 x 3.2 mm

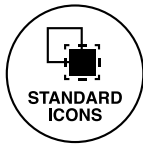

CSMS15CIC04 - White Capacitive Touch LED Sensor with a Display Size of 0.59 x 0.59 inches (15 x 15 mm) square



Application

- Mobile communication devices
- Electronic devices
- Point of sale terminals
- Industrial control displays
- Touch screen monitors
- Media players
- Food service appliances
- Appliances and consumer equipments

Key features

- Integrated touch sensing and LED display technology
- Enables the device interface to be more user friendly and intuitive
- Allow Top Mount and Reverse Mount design
- Available in one standard size: 15.0mm x 15.00mm x 3.2mm
- Available in 5 colors: super red, white, pure green, blue or yellow
- Touch sensor: integrated circuit (IC)
- Uniform illumination and high optical clarity due to LED technology
- Robust design due to no mechanical moving parts
- Simplifies devices design and manufacturability
- Optional overlay (icons): on/off, arrow, alarm (sold separately)
- Capacitive Touch Display can also be mounted behind clear glass or plastic layer such as polycarbonate or acrylic
- Capacitive sensor still functional when hands are wet
- Capacitive sensor still functional when hands are covered with certain types of gloves

Ordering Data

The CSM Series (Capacitive Touch Sensor LED Display) is available in a range of standard features and options. To specify simply choose one option from each column.

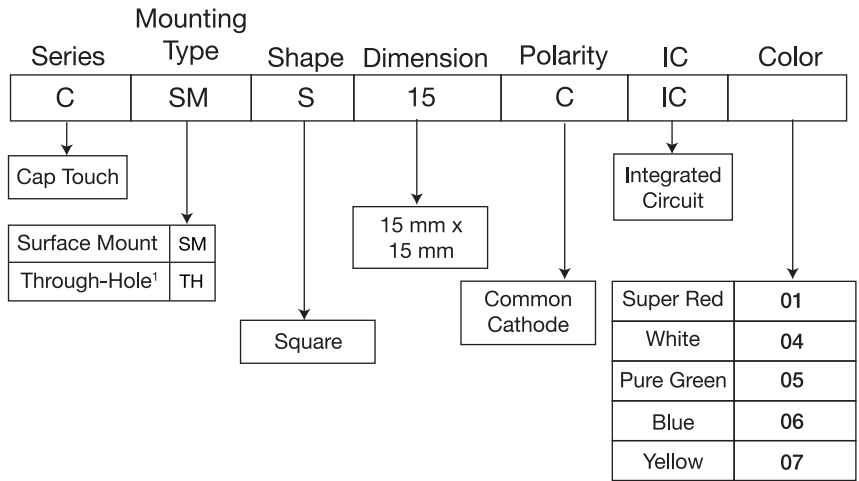

¹For Through-Hole version, please refer to CTH Series Datasheets

Application Circuit

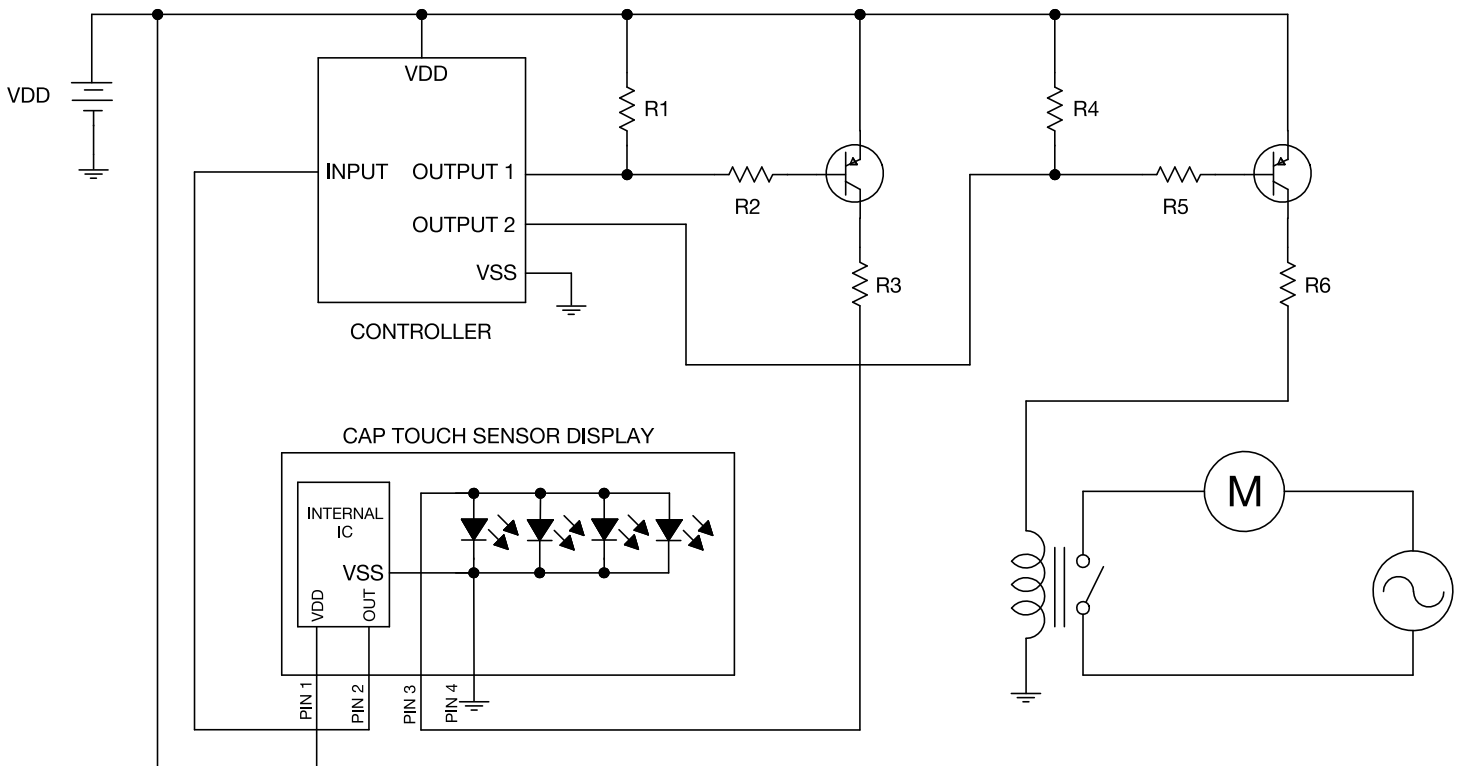

Package Dimensions

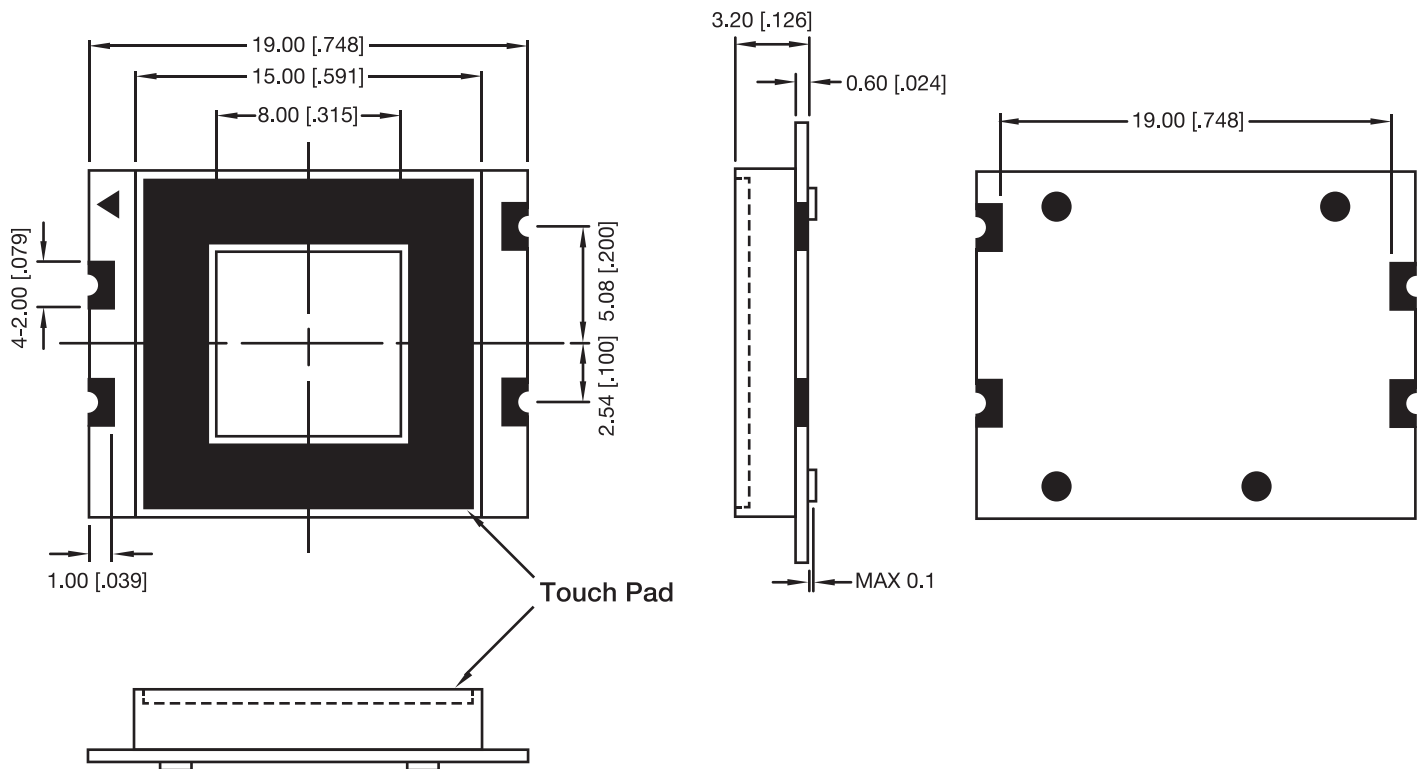

Notes

- Dimensions are in millimeter [inch]
Tolerance is ± 0.25 [0.010] and angle is $\pm 1^\circ$ unless otherwise noted

Features

- Touch Display with Drive IC
- SMD Type
- RoHS Compliant
- Low Power Consumption
- Easy Mounting on P.C. Board or Socket

Typical Internal Equivalent Circuit

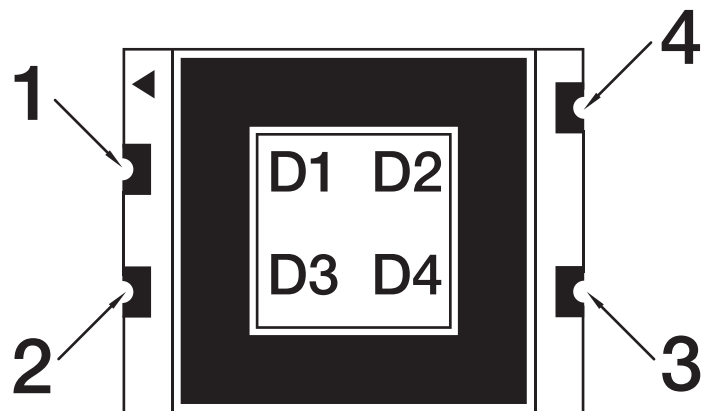

Internal Circuit Diagram

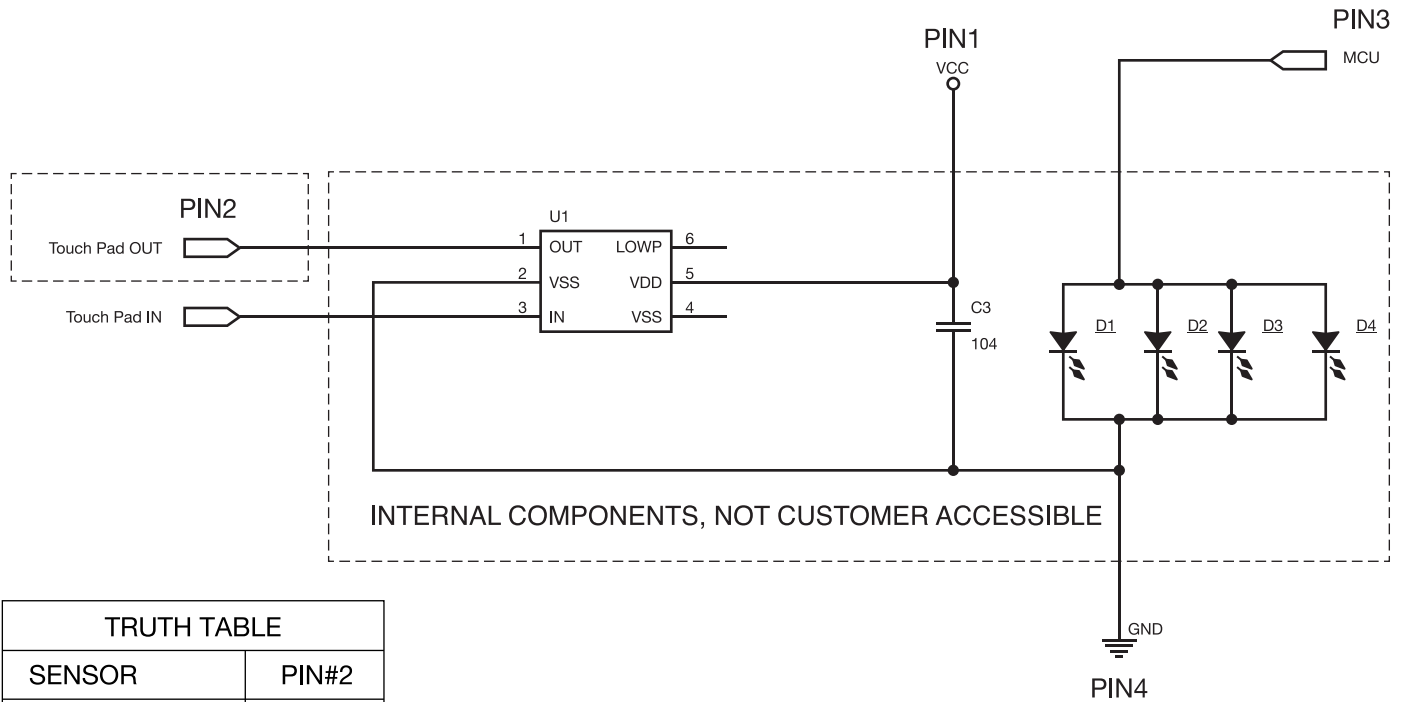

TRUTH TABLE	
SENSOR	PIN#2
NOT TOUCHED	LOW
TOUCHED	HIGH

Internal IC Electrical Characteristics

(TA = 25°C, unless otherwise specified)

	Symbol	Min.	Typ.	Max.	Unit	Condition
Supply Voltage	V_{DD}	2.0	--	5.5	V	--
High Level Input Voltage	V_{IH}	3.5	--	5	V	$V_{DD} = 5V$
Low Level Input Voltage	V_{IL}	0	--	1.5	V	$V_{DD} = 5V$
Operating Current	I_{DD1}	--	16	--	μA	$V_{DD} = 5V$ No load
		--	3.5	--		$V_{DD} = 3V$ No load
Operating Current (SLRT = V_{DD})	I_{DD2}	--	10.5	--	μA	$V_{DD} = 5V$ No load
		--	2.5	--		$V_{DD} = 3V$ No load
Low Level Output Current	I_{OL}	--	30	--	mA	$V_{DD} = 3V$ $V_{OL} = 1V$
High Level Output Current	I_{OH}	--	8	--	mA	$V_{DD} = 3V$ $V_{OH} = 2V$

ABSOLUTE MAXIMUM RATING FOR LED

(Ta=25°C)

	Symbol	Rating	Unit
Power Dissipation (Per Dice)	P_D	114	mW
Continuous Forward Current (Per Dice)	I_F	30	mA
Peak Current (Per Dice, duty cycle 1/10,1KHz)	I_{FP}	100	mA
Derating Liner from 25°C (Per Dice)	$\Delta I_F / \Delta T$	0.4	mA / °C
Reverse Voltage (Per Dice)	V_R	5	V
Operating Temp.	T_{OPR}	-40 ~ +105	°C
Storage Temp.	T_{STG}	-40 ~ +105	°C
Electrostatic Discharge (HBM)	ESD	1500	V
Hand Soldering Temperature	T_{SOL}	350	°C

ELECTRO-OPTICAL CHARACTERISTICS

(Ta=25°C)

	Symbol	Min.	Typ.	Max.	Unit	Condition
Luminous Intensity	I_v	288	522	--	mcd	$I_F = 20 \text{ mA}$
Forward Voltage	V_F	--	3.2	3.8	V	$I_F = 20 \text{ mA}$
Dominant Wavelength (Tolerance: ± 0.01)	x	--	0.27	--	--	$I_F = 20 \text{ mA}$
	y	--	0.25	--	--	$I_F = 20 \text{ mA}$
Reverse Current	I_R		-	100	μA	$V_R = 5\text{V}$

ELECTRICAL/OPTICAL CHARACTERISTICS CURVES

(Ta=25°C)

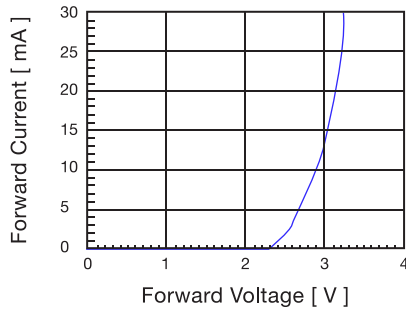

Fig 1. Forward Current vs. Forward Voltage

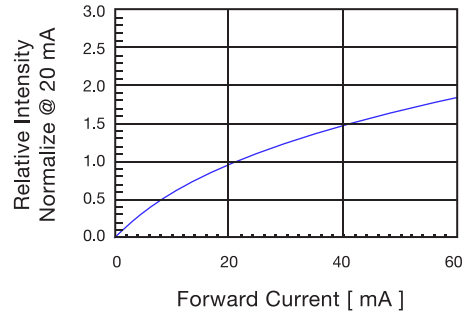

Fig 2. Relative Intensity vs. Forward Current

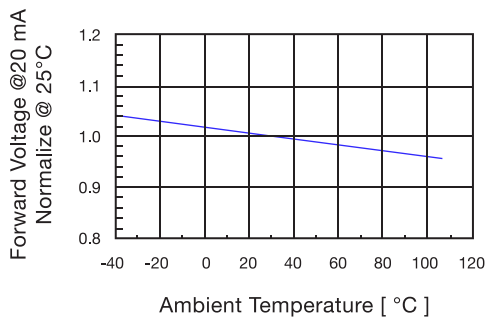

Fig 3. Forward Voltage vs. Temperature

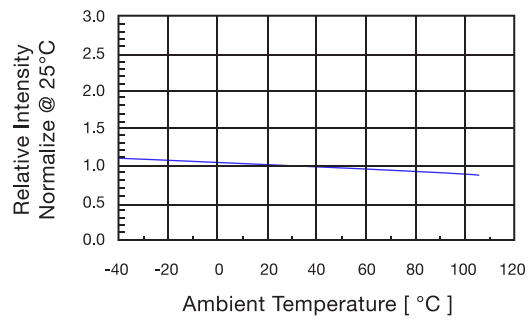

Fig 4. Relative Intensity vs. Temperature

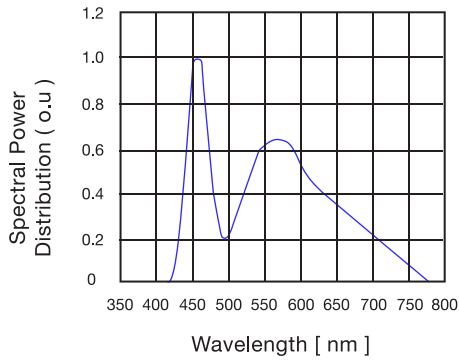

Fig 5. Spectral Power Distribution

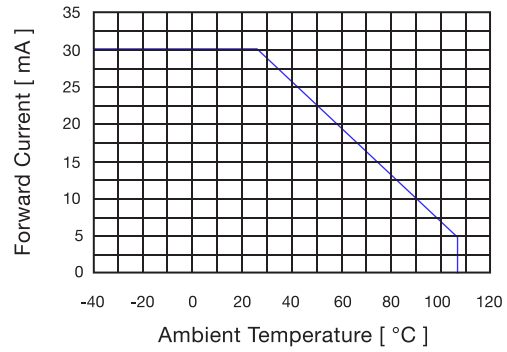
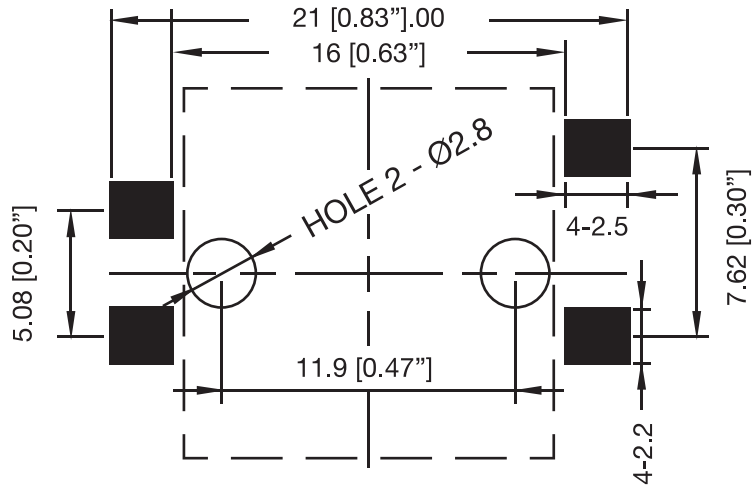
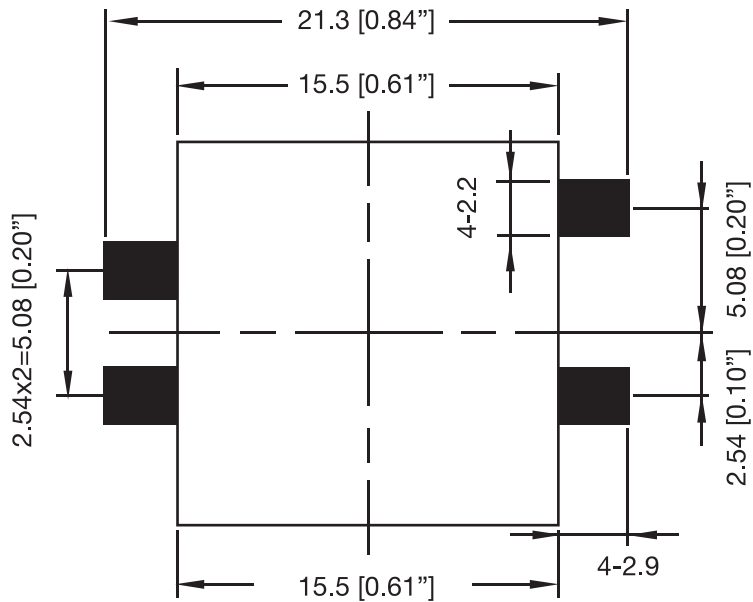

Fig 6. Forward current vs. Temperature

SOLDERING PAD SIZE



Top Mount



Reverse Mount

Dimensions are in millimeter [inch]

SOLDERING CHARACTERISTICS

1. IR-reflow Condition (Pb free)

Area	Title	Symbol	Min.	Max.	Unit
(1)Preheat	Ramp-up rate	V_P	1	5	°C/sec
	Temperature	T_P	150	--	°C
	Time	t_p	--	--	sec
(2)Equilibrium	Ramp-up rate	V_E	--	--	°C/sec
	Temperature	T_E	150	200	°C
	Time	t_e	60	120	sec
(3)Reflow	Ramp-up rate	V_R	1	5	°C/sec
	Temperature	T_R	220	--	°C
	Time	t_r	--	60	sec
(4)Cooling	Ramp-up rate	V_{RP}	--	260	°C
	Temperature	t_{rp}	--	10	sec
	Time	V_C	3	6	°C/sec

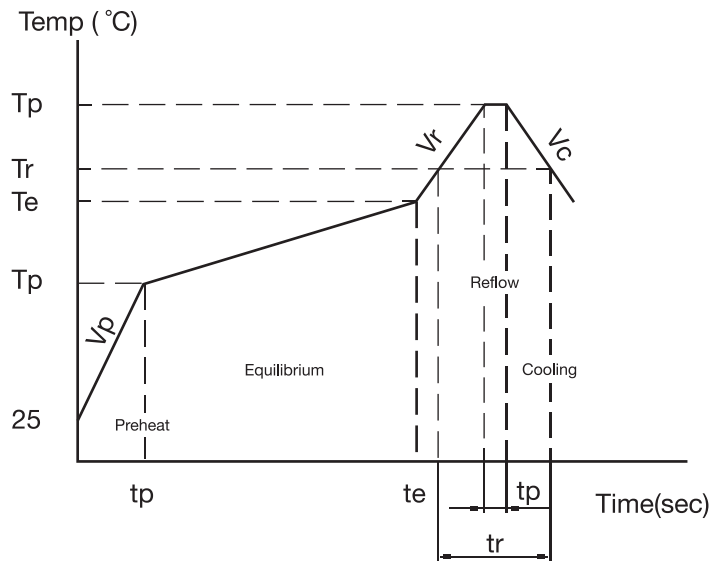

2. Hand Soldering (Iron Condition)



Soldering Iron: 30W Max
 Temperature 350°C Max
 Soldering Time: 3 Seconds Max (One Time)
 Distance: 1.6mm min (From Seating Plane)

* If you choose to add the overlay (optional) it should be applied after reflow

Overlay (Sold Separately)

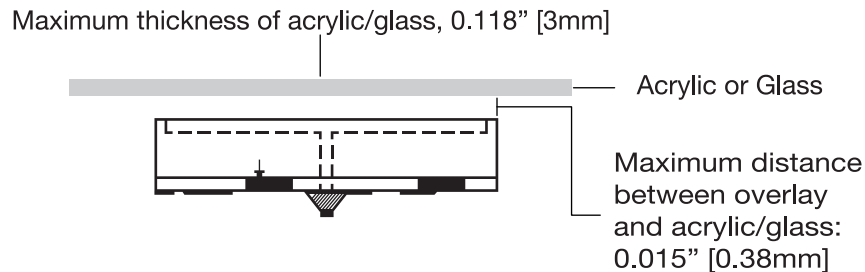
- Standard Icons: Arrow, On/OFF, Alarm
- Icons combines interactive control with color identification to ease and accelerate user interactions for any device
- Reverse printed translucent clear icons for capacitive touch sensor LED backlighting
- Overlay lamination with optically clear adhesive
- Optically clear adhesive for easy installation, high cohesive, and long term durability
- When the CTH or CSM are turned off you can still see the standard icon overlay
- Offers high-temperature capability, high hardness, use resistance, and chemical inertness
- Custom icons are also available upon request [contact a VCC representative]
- Suggested overlay size: 0.590" x 0.590"



Icon	Part Number
	CTHOVERLAYONOFF
	CTHOVERLAYARROW
	CTHOVERLAYALARM

For more information, please refer to the most recent overlay datasheet available on our website

Overlay Installation Instructions

Before you begin set up your mat and antistatic wrist strap.

Professional service technicians use grounding straps to minimize the chances of electrostatic discharge (ESD) during normal maintenance involving electronic devices.

These antistatic devices may be placed around the wrists or ankles to ground the technician to the system being worked on. These straps release any static present on the technician's body and pass it harmlessly to ground potential.

Use the appropriate equipment.

An antistatic bag is a bag used to store electronic components, which are prone to damage caused electrostatic discharge (ESD).

Steps:

Note: if using reflow soldering the overlay must be installed afterwards as a second operation

- 1) Peel the overlay (adhesive) off its white sheet without removing the transparent film (**Figure 1**)
- 2) Apply the overlay over the capacitive touch sensor component (**Figure 2**) without removing the protective face line. Be sure to align or orientate the overlay properly.
- 3) Be sure check for no contamination in the ignition zone this can be done with electrical test (**Figure 4,5,6**)
- 4) The protective film can either be removed in the assembly line or by the end user

Figure 1

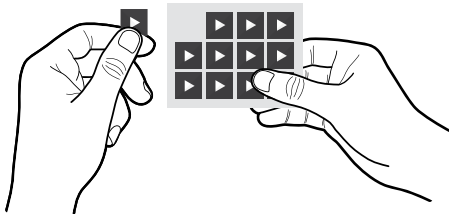

Figure 2

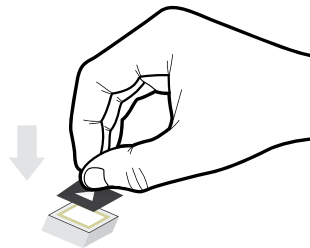

Figure 3

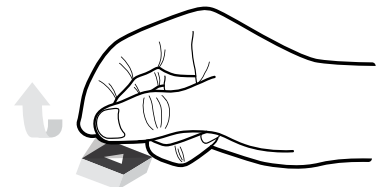

Figure 4

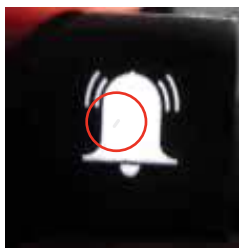
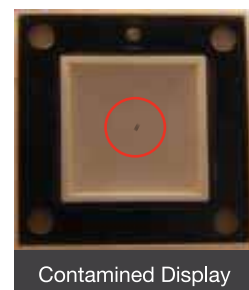

Figure 5



Figure 6



Storage Method

• Storage Conditions

A. Before opening the package:

The LEDs should be kept at $-40^{\circ}\text{C} \sim 105^{\circ}\text{C}$ and RH: 45% ~ 85%. The LEDs should be used within a year. When storing the LEDs, moisture proof packaging with absorbent material (silica gel) is recommended.

B. After opening the package:

The LEDs should be kept at $\leq 30^{\circ}\text{C}$ and $\leq 70\% \text{RH}$. The LEDs should be soldered within 168 hours (7) after opening the package. If unused LEDs remain, they should be stored in moisture proof packages, such as sealed containers with packages of moisture absorbent material (silica gel). It is also recommended to return the LEDs to the original moisture proof bag and to reseal the moisture proof bag again.

• If the moisture absorbent material (silica gel) has faded away or the LEDs have exceeded the storage time, baking treatment should be performed using the following conditions.

Baking treatment: more than 24 hours at $65 \pm 5^{\circ}\text{C}$

Reel Dimension

Dimensions are in millimeter [inch]

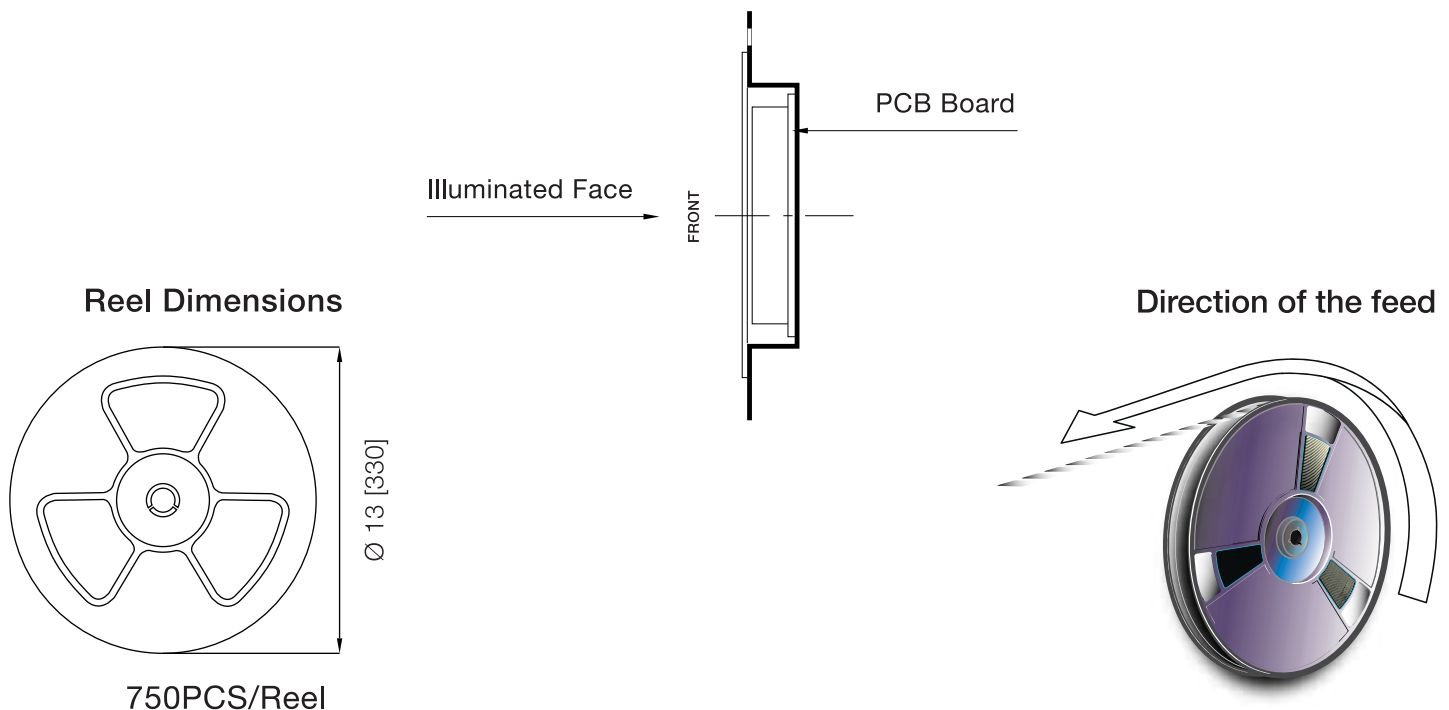

Compliances and Approvals

