

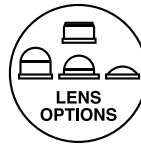

# 1092 Series 0.500" (12.7mm) Tab Terminals LED Panel Mount Indicator



1092 Series with high brightness LED offers daylight visibility and enhances the user experience by enabling fast operation of the device



## Applications

- Industrial
- Transportation
- Food Service
- People Mover
- Medical
- Maritime
- Oil and Gas Industry
- Manufacturing
- Automation & Control

## Key features

- Front panel snap-in. Snaps fit into 0.500" (12.7mm) panel hole requires no additional hardware
- High brightness LED for daylight viewing
- Available in five single LED colors: red, green, amber, blue and white
- Available in five single lens colors: red, green, amber, blue and clear
- Offered with a variety of lens options: Hi Hat, Hi Dome, Semi Dome and Small Dome
- Transparent and diffused lenses provide visibility during daylight
- Available in operating voltage of 12VAC/DC, 28VAC/DC and 125VAC
- Offered with wire leads (4.4"/4.8") or tab terminal (0.187" x .020")
- "Double D" mounting hole prevent any rotation of the indicator while the nut is being installed.
- Bezel finish: Polished stainless steel
- Designed, manufactured and tested in accordance with the relevant UL and CSA standards
- Order speed nuts separately to provide maximum fastening power with minimal installation torque
- Order gasket separately to provide water, oil, air and dust tight
- Compliant with RoHS and REACH requirements

# Ordering Data

The 1092 Series is available in a range of standard features and options. To specify your Panel Mount Indicator, simply choose one option from each column. An example is shown below

Series	Lens Style	Color			Voltage	
1092Q	A	5	-		12	

Hi-Dome	A
Hi-Hat	C
Semi-Dome	D
Small-Dome	M

		luminous intensity (Typ)
Red	1	13,000 mcd
Amber	3	13,000 mcd
Green	5	12,000 mcd
Clear	2	7,000 mcd
Blue	6	3,200 mcd

12V	12V
28V	28V
125VAC	125VAC

**Example: 1092QD5-12V**  
 1092 Tab Terminals with Semi-Dome lens - Green LED and 12 Volts



## Accessories Ordering Data [order separately]

Speed Nut: SN0461-C



O'Ring Gasket: SPC472



# Product Dimensions

## Hi-Dome

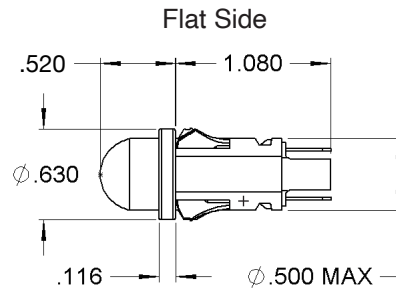
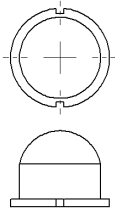

## Hi-Hat

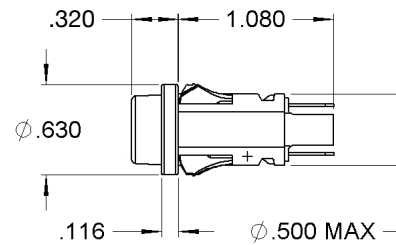
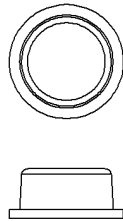

## Semi Dome

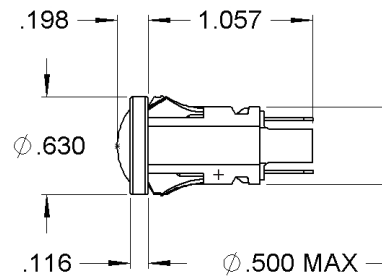
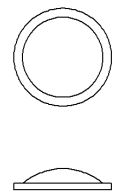

## Small Dome

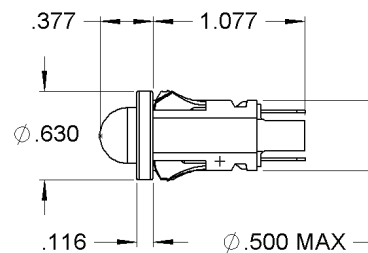

## Mounting Hole (All)

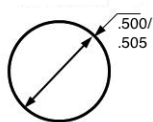

Standard Mounting Hole

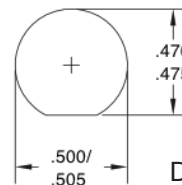

D-Mounting Hole

### Note:

1. Polarity mark (+) applies only for versions 12VDC and 28VDC on the flat side.
2. Dimensions in inches

## Product Specifications

Materials	
Housing	White Nylon UL94 V-2
Lens	Transparent Polycarbonate UL94 V-2
Bezel	Polished stainless steel
Tab terminals	Quick-connect tinned brass

Voltage Table		
Nominal	VAC	VDC
12V	10 to 14	10 to 14
28V	26 to 30	26 to 30
125V	105 to 125	-

Temperature Specifications	
Operating Temperature	-40°C to +85°C -40°F to +185°F
Storage Temperature	-40°C to +85°C -40°F to +185°F

Installation Specifications	
Mounting Hole	0.500" to 0.505" (12.70 to 12.83 mm)
D-Mounting Hole	0.470" to 0.475" (11.94 to 12.07 mm)
Panel Thickness	0.020" to 0.100" (0.51 to 2.54 mm)
Tab Terminals	0.187" (4.75mm) terminals

Internal Resistor	
12V	390Ω
28V	1200Ω
125V	15000Ω + rectifier diode

Forward Current Rating	25mA
------------------------	------

## Accessory options [order separately]

### O-Ring Gasket

Part Number: **SPC472**

The 1092 Gasket is designed to seal many types of media, including water, air, dust, and oil.

The panel gasket is intended to provide a seal between the panel and the 1092 Panel Mount Indicator.

Meets ASTM D2000 standard.

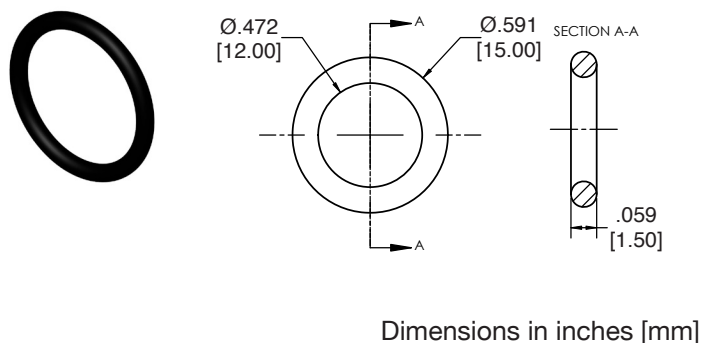

Material
Buna-N, Durometer A50, black

Installation Specification	
Internal Diameter	0.472" (12 mm)
28V	0.059" (1.5 mm)
Operational Temperature	-30°F to +225°F

## Accessory options [order separately]

### Push-on speed nut

Part Number: **SN0461-C**

Description: Speed nut with coating, which secures the indicator in place

- One piece, self-locking, heat-treated, spring-steel fastener that replaces threaded nut, lock washer or spanner washer
- Eliminates time-consuming assembly operations
- Fast and easy to apply, the speed nut fastener provides maximum holding power at minimum cost per fastener
- It does not shake loose from vibration, yet can be easily loosened without worry about rust-frozen screw threads
- For smaller components where space is premium
- Requires less torque than standard hex-nuts
- Can be installed prior to painting process so threads won't fill.

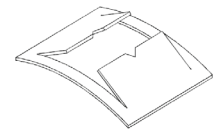
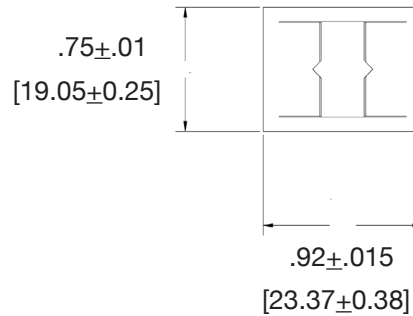
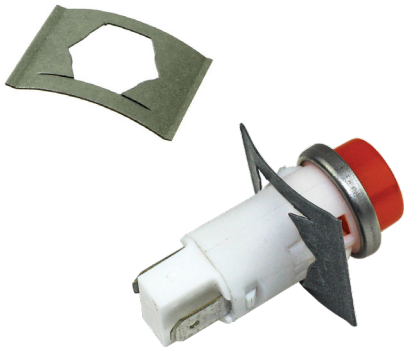

Dimensions in inches [mm]

Material	
Speed Nut (one piece)	Spring Steel

Installation Specification	
Stud Size	0.485" (12.319mm)

## Compliances and Approvals

